

# WIZ110SR User's Manual

(Version1.0)

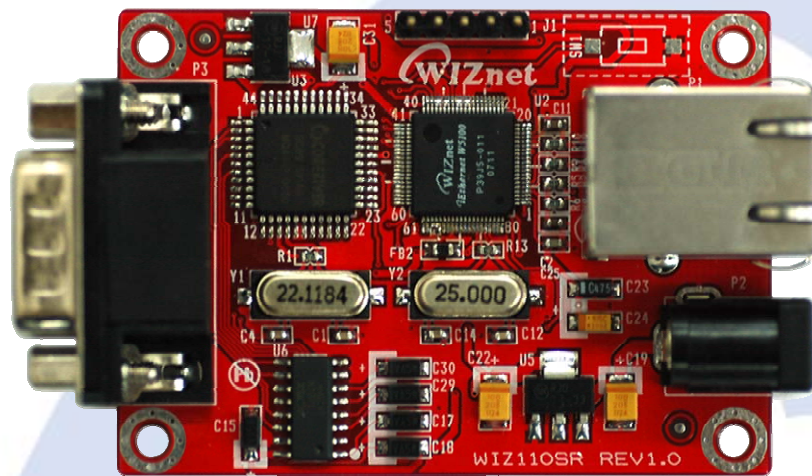

©2007 WIZnet Co., Ltd. All Rights Reserved.

For more information, visit our website at <http://www.wiznet.co.kr>

# WIZnet's Online Technical Support

If you have something to ask about WIZnet products, write down your question on [Q&A Board](#) in WIZnet website ([www.wiznet.co.kr](http://www.wiznet.co.kr)). WIZnet will give an answer as soon as possible.

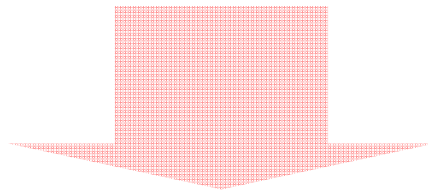
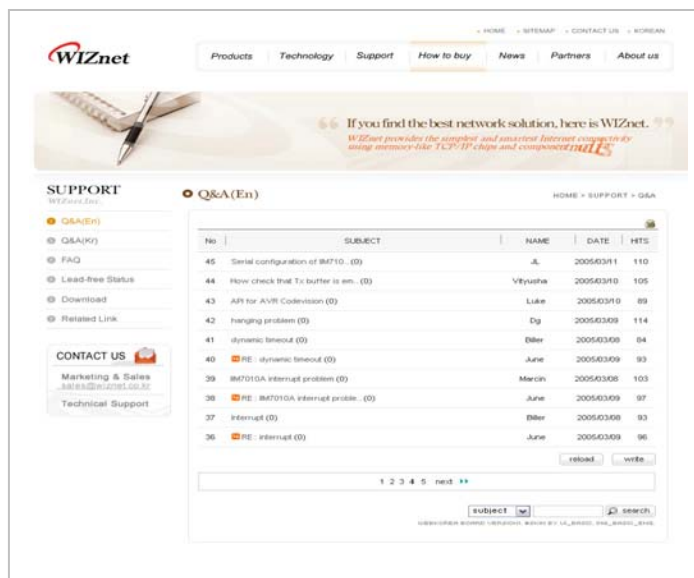
HOME > SUPPORT > Q&A

No.	SUBJECT	NAME	DATE	HTS
45	Serial configuration of BM710. (0)	JL	20050311	110
44	How check that Tx buffer is em. (0)	Viyusha	20050310	105
43	API for AVR Codemison (0)	Luke	20050310	89
42	hanging problem (0)	Dg	20050309	114
41	dynamic timeout (0)	Blaw	20050309	84
40	RE : dynamic timeout (0)	June	20050309	93
39	BM7010A internet problem (0)	Mercin	20050308	103
38	RE : BM7010A internet proble. (0)	June	20050309	97
37	internet (0)	Blaw	20050308	93
36	RE : internet (0)	June	20050309	96

1 2 3 4 5 next >>

subject search

## Table of Contents

<b>1. INTRODUCTION.....</b>	<b>5</b>
1.1 KEY FEATURES.....	5
1.2 SPECIFICATION.....	6
1.3 PRODUCTS CONTENTS .....	6
<b>2. WIZ110SR BOARD.....</b>	<b>8</b>
2.1 BLOCK DIAGRAM.....	8
2.2 CONFIGURATION TOOL.....	9
<b>3. FIRMWARE UPLOAD .....</b>	<b>17</b>
<b>4. DEMONSTRATION AND TEST .....</b>	<b>19</b>
4.1 HARDWARE INTERFACE .....	19
4.2 TESTING “SERIAL TO ETHERNET” FUNCTION .....	20
<b>5. HARDWARE DESCRIPTION OF WIZ110SR.....</b>	<b>22</b>
5.1 PARAMETERS.....	22
5.2 SPECIFICATION.....	22
5.3 BOARD DIMENSIONS AND PIN ASSIGNMENT .....	22
<b>6. WARRANTY.....</b>	<b>25</b>

## FIGURES

Figure 1. Block Diagram .....	8
Figure 2. Configuration Tool (Network Config).....	9
Figure 3. TCP Server mode.....	11
Figure 4. TCP Client mode .....	11
Figure 5. UDP mode .....	12
Figure 6. Configuration Tool (Serial Config.) .....	14
Figure 7. Configuration Tool (Option Config.).....	15
Figure 8. Board Search Window .....	17
Figure 9. Open dialog box for uploading.....	18
Figure 10. Firmware uploading window.....	18
Figure 11. Complete Uploading .....	18
Figure 12. WIZ110SR Interface .....	19
Figure 13. Device Terminal.....	21
Figure 14. WIZ110SR Board Dimension .....	23
Figure 15. RJ-45 PIN Assignment .....	24
Figure 16. RS-232 PIN Assignment.....	24

## Tables

Table 1. WIZ110SR Specification .....	6
Table 2. Products Contents.....	7

## 1. Introduction

WIZ110SR is a gateway module that converts RS-232 protocol into TCP/IP protocol. It enables remote gauging, managing and control of a device through the network based on Ethernet and TCP/IP by connecting to the existing equipment with RS-232 serial interface.

### 1.1 Key Features



- Direct Connection to the Serial Device
  - Adding Network Function Simply and Quickly
  - Providing Firmware Customization
- System Stability and Reliability by using W5100 Hardware Chip
- Configuration Tool Program
- 10/100 Ethernet Interface and max 230Kbps Serial Interface
- RoHS Compliant

## 1.2 Specification

Items	Description
MCU	8051 Compliant (having internal 62K Flash, 16K SRAM, 2K EEPROM)
TCP/IP	W5100 (Ethernet PHY Embedded)
Network Interface	10/100 Mbps auto-sensing RJ-45 Connector
Serial Interface	RS232
Serial Signal	TXD, RXD, RTS, CTS, GND
Serial Parameters	Parity : None, Even, Odd
	Data Bits : 7,8
	Flow Control : None, RTS/CTS, XON/XOFF
	Speed : up to 230Kbps
Input Voltage	DC 5V
Power Consumption	Under 180mA
Temperature	0°C ~ 80°C (Operation), -40°C ~ 85°C (Storage)
Humidity	10 ~ 90%

Table 1. WIZ110SR Specification

## 1.3 Products Contents

	<p>WIZ110SR Board</p>
	<p>CD (Option / including Firmware, Configuration Tool Program Manual and other related materials)</p>



	<p>LAN Cable (Option)</p>
	<p>5V Power Adaptor (Option)</p>

Table 2. Products Contents

## 2. WIZ110SR Board

### 2.1 Block Diagram

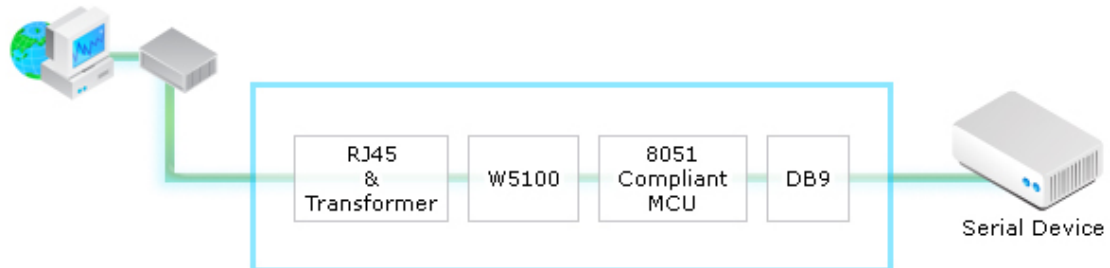

Figure 1. Block Diagram

WIZ110SR is a protocol converter that transmits the data sent by serial equipment as TCP/IP data type and converts back the TCP/IP data received through the network into serial data to transmit back to the equipment. When the data is received from serial port, it is sent to W5100 by MCU. If any data is transmitted from Ethernet, it is received in the internal buffer if W5100, and sent to the serial port by MCU. MCU in the module controls the data according to the configuration value that user defined.



## 2.2 Configuration Tool

### 2.2.1 Network Configuration

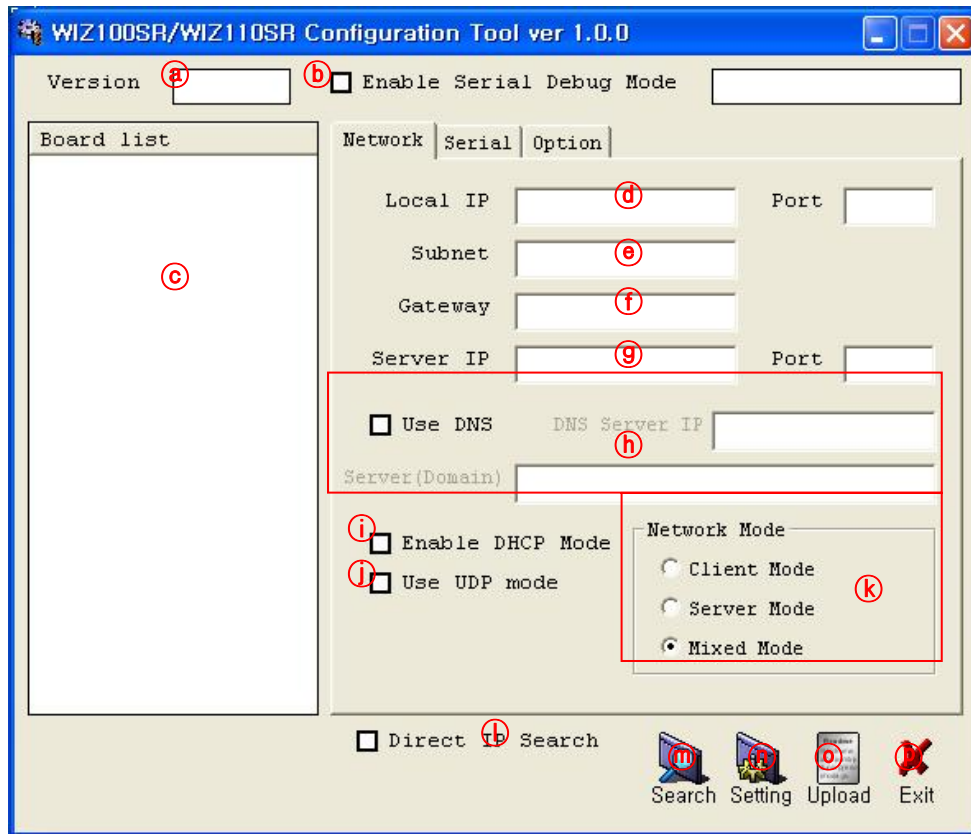

Figure 2. Configuration Tool (Network Config)

Ⓐ **Version** : Displays firmware version.

Ⓑ **Enable Serial Debug Mode** : If this mode is checked, you can monitor the status and socket message of WIZ110SR (listen OK, connect fail etc.) through serial terminal. If Debug mode is on, debug message can cause abnormal operation of the serial device. Therefore, just use this mode only for Debug mode.

Ⓒ **Board List** : If you click "Search" button, all the MAC addresses on a same subnet, will be displayed.

④ Local IP/Port : WIZ100SR's IP address and Port number for network connection

⑤ Subnet : WIZ110SR's subnet mask

⑥ Gateway : WIZ110SR's Gateway address

⑧ Server IP/Port : When WIZ110SR is set as "Client mode" or Mixed mode", server IP and port should be set. WIZ110SR attempts to connect this IP address.

⑩ Use DNS : If DNS function is needed, check this option and input the domain name of DNS server. DNS(Domain Name System) is the database system having information about IP address and corresponding domain name. When connecting to domain name, you can use DNS function of WIZ110SR. Input IP address of DNS server provided by ISP in *DNS Server IP*, and domain name in the *Server (Domain)*

⑪ Enable DHCP Mode :

Set this option to use DHCP mode. First, check 'Enable DHCP mode' and click 'Setting' button. If IP address is successfully acquired from DHCP server, the MAC address will be displayed on the board list. (It takes some time to acquire IP address from DHCP server)

When a module on the board list is selected, IP address, Subnet mask and Gateway are displayed. If module could not acquire network information from DHCP server, IP address, Gateway Address and Subnet mask will be initialized to 0.0.0.0.

⑫ Network mode: client/server/mixed :

This is to select the communication method based on TCP - TCP Server, TCP Client, and Mixed. TCP is the protocol to establish the connection before data communication, but UDP just proceeds the data communication without connection establishment.

TCP Server operates as a server and TCP Client as a client on the connection establishment. The mixed mode supports both of TCP server and client.

**☞ This Network mode is just related to the connection establishment process. It just defines who will request the connection first and who will be waiting for the connection requests.**

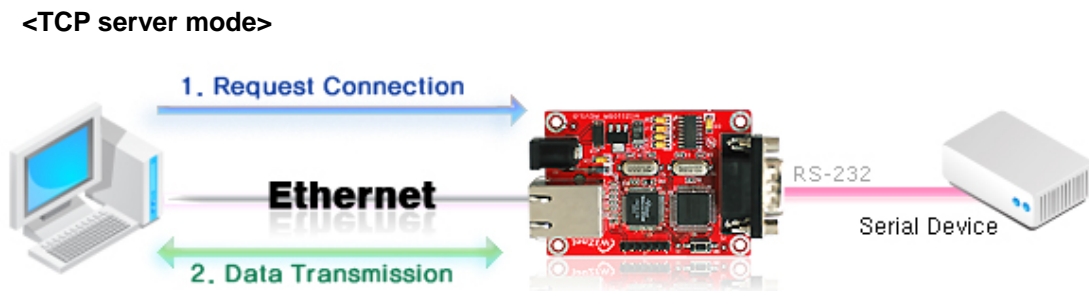

Figure 3. TCP Server mode

At the TCP Server mode, WIZ110SR waits for the connection requests.

TCP Server mode can be useful when the monitoring center tries to connect to the device (where WIZ110SR is installed) in order to check the status or provide the commands. In normal time WIZ110SR is on the waiting status, and if there is any connection request from the monitoring center, data communication is processed and connection is closed.

In order to operate this mode, Local IP, Subnet, Gateway Address and Local Port Number should be configured first.

As illustrated in the above figure, data transmission proceeds as follows,

1. The host connects to the WIZ110SR which is configured as TCP Server mode.
2. As the connection is established, data can be transmitted in both directions - from the host to the WIZ110SR, and from the WIZ110SR to the host

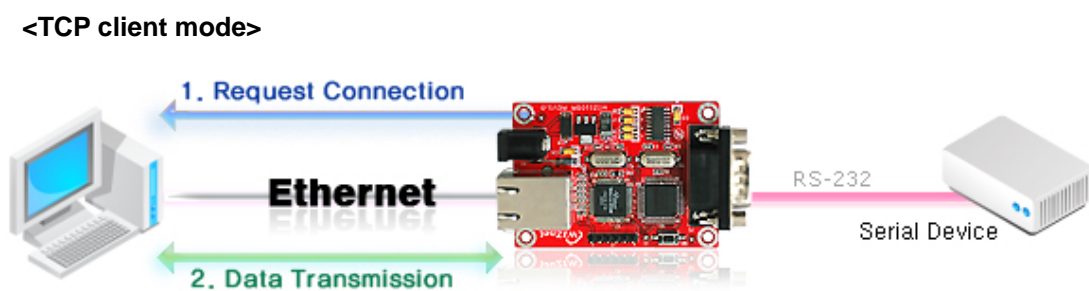

Figure 4. TCP Client mode

If WIZ110SR is set as TCP Client, it tries to establish connection to the server.

To operate this mode, Local IP, Subnet, Gateway Address, Server IP, and Server port number should be set. If server IP had domain name, use DNS function.

In TCP Client mode, WIZ110SR can actively establish a TCP connection to a host computer when power is supplied.

As illustrated in the above figure, data transmission proceeds as follows:

1. As power is supplied, WIZ110SR board operating as TCP client mode actively establishes a connection to the server.
2. If the connection is complete, data can be transmitted in both directions - from the host to the WIZ110SR and from WIZ110SR to the host

#### <Mixed mode>

In this mode, WIZ110SR normally operates as TCP Server and waits for the connection request from the peer. However, if WIZ110SR receives data from the serial device before connection is established, it changes to the client mode and sends the data to the server IP. Therefore, at the mixed mode, the server mode is operated prior to the client mode.

As like TCP Server mode, the Mixed mode is useful for the case that the monitoring center tries to connect to the serial device (in which WIZ110SR is used) to check device status. In addition to this, if any emergency occurs in the serial device, the module will change to Client mode to establish the connection to the server and deliver the emergency status of the device

#### Ⓚ Use UDP mode

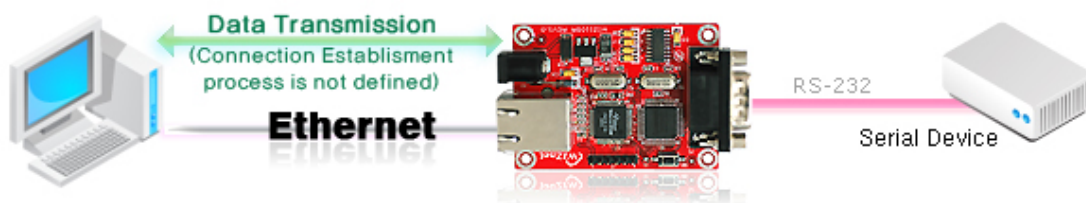

Figure 5. UDP mode

At the UDP mode, the connection establishment is not defined. Just set the IP address and port number of the peer and send the data.

### ① Direct IP Search

Direct IP Search can be used for searching WIZ110SR not installed in the same subnet.

If the Direct IP search is checked, the configuration tool use the TCP instead UDP broadcast to search modules. Therefore, network information of the module such as IP address, subnet mask and gateway is required.

If you check Direct IP search, the field to input IP address will be activated. In this field, input IP address of the module, and click "Search" button.

**☞ If module does not have valid network information, Direct IP search is not available.**

### ② Search

The Search function is used to search all modules existing on the same LAN. By using UDP broadcast, all modules on the same subnet will be searched.

The searched module is displayed as MAC address in the "Board list".

### ③ Setting

This function is to complete the configuration change.

If you select the MAC address from the "Board list", the default configuration value of the module will be displayed. Change the configuration and click "Setting" button to complete the configuration. The module will re-initialize with the changed configuration.

The configuration value can be changed in below steps.

- ① Select the mac address of which configuration value should be changed in the "Board list. The values configured will be displayed.
- ② Change the value
- ③ Click "Setting" button. The configuration change will be complete.
- ④ The module will be initialized to the changed values (re-booting is processed)

### ④ Upload

Firmware will be uploaded through network

**☞ After uploading the firmware, 20~30 seconds are required for initialization.**

⑤ **Exit** : Close the configuration tool program.

## 2.2.2 Serial configuration

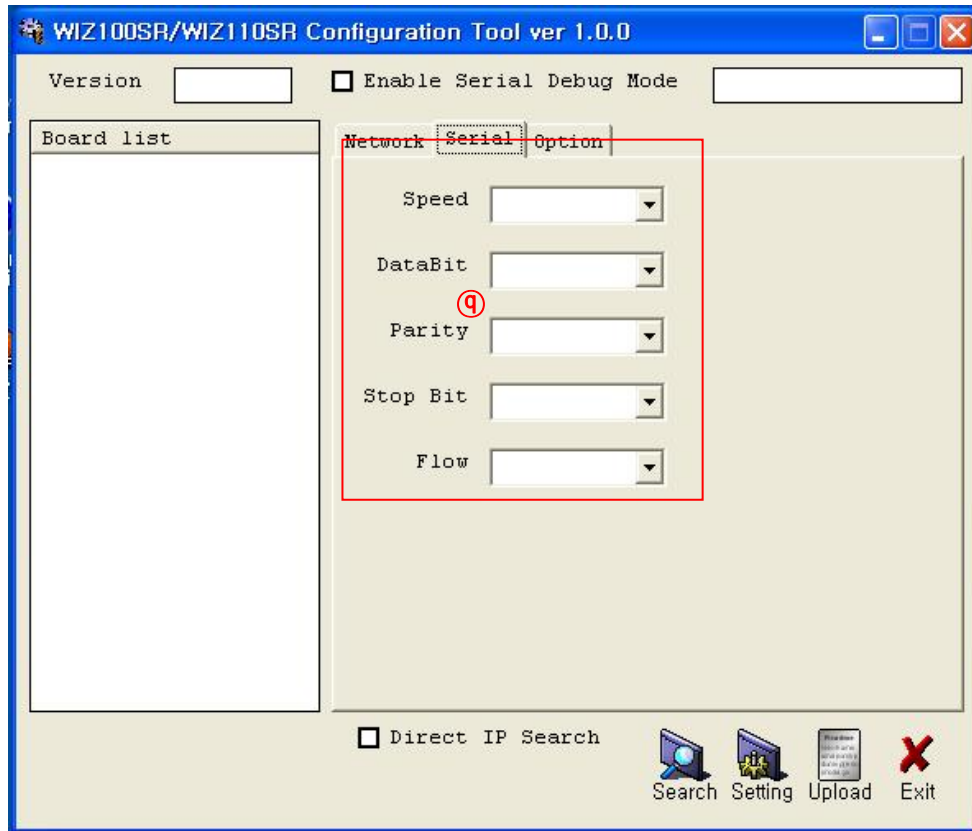

Figure 6. Configuration Tool (Serial Config.)

#### ⑨ Serial

Serial Configuration value of selected module is displayed.

In order to change the serial configuration of WIZ100SR, this menu can be used.

☞ **By clicking the "Setting" button, changed value can be applied.**

#### 2.2.3 Option configuration

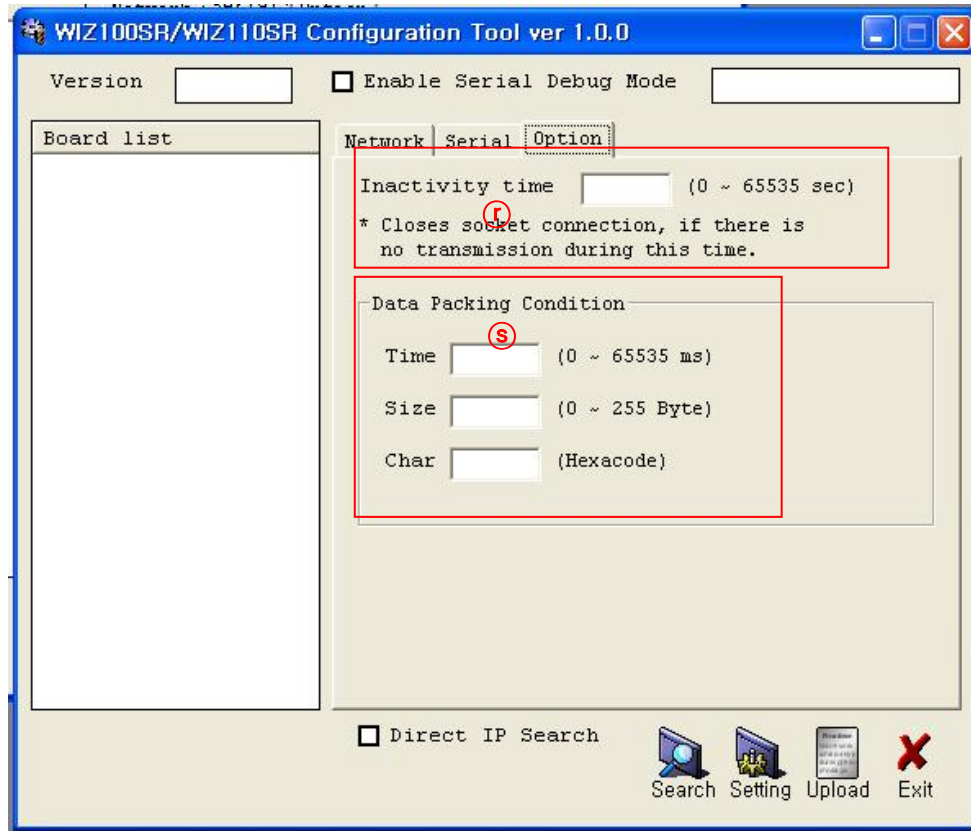

Figure 7. Configuration Tool (Option Config.)

#### Ⓛ Inactivity time

After the connection is established, if there is not data transmission within the time defined in Inactivity time, the connection is closed automatically.

The default value is '0'. If '0' is set, this function is not activated. In this default setting, the connection is maintained even though there is no data transmission. In order to close the connection, the 'Close' command should be given.

This function can be used for more than two or more systems to connect to a WIZ110SR module. If one system keeps connection to the WIZ110SR, other systems can not connect to the module. If there is no data transmission during the time defined in Inactivity time, the connection will be closed for other system to be connected.

Inactivity Time also can be useful for the case when the server system is unexpectedly shut down. In this status, if there is not any data communication during the time defined in the Inactivity time, WIZ110SR will close the connection and enter into waiting status.

### ③ Data Packing Condition

You can designate how the serial data can be packed to be sent to the Ethernet. There are 3 delimiters - time, size and character. If all of them are set as '0', whenever the serial data is arrived, they are sent to the Ethernet.

- a. Time: Every designated time, serial data converted to Ethernet.
- b. Size: Every designated data size, serial data converted to Ethernet.
- c. Char: Every designated character, serial data converted to Ethernet. (It's available only Hex.)

When any of three delimiters is satisfied, data can be sent to the Ethernet.

Ex) Delimiter: Size=10, Char=0x0D

Serial data : 0123456789abc

Ethernet data : 0123456789

☞ "abc" data remains in the serial buffer of module



### 3. Firmware Upload

- ① Run 'WIZ100SR/WIZ110SR Configuration Tool' program, and click "Search" button.
- ② If the module is properly connected to the network, "Complete searching" message and MAC address will be displayed on the "Board List" as shown in below.

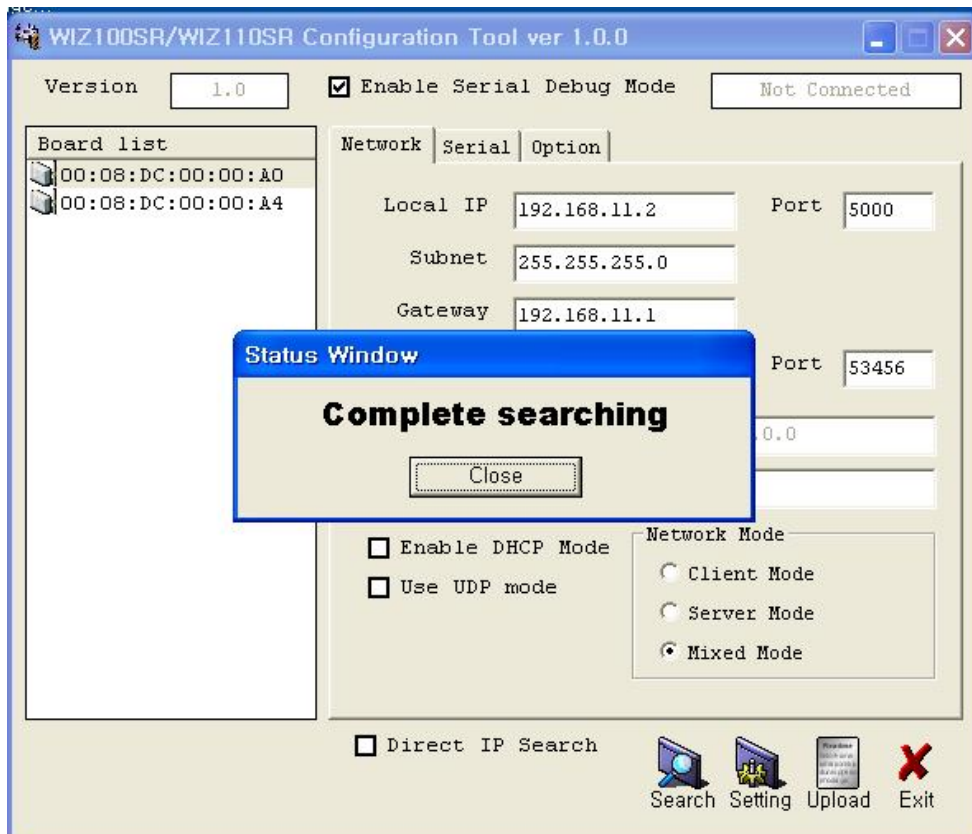

Figure 8. Board Search Window

- ③ Select a module shown in "Board list", and click "Upload" button.  
**Before uploading through Ethernet, you should set the network information of WIZ11SR first by Configuration Tool program as shown above figure. By using PING test, you can check if network is correctly configured.**
- ④ When the window as shown in below figure, select file to upload and click "Open" button.

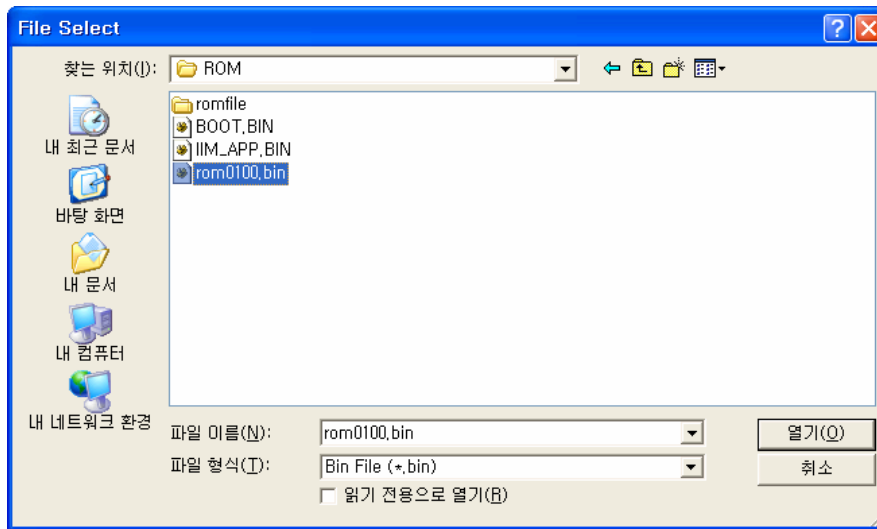

Figure 9. Open dialog box for uploading

⚠ Do not upload any other files except for WIZ110SR firmware file.

⑤ A dialogue box titled “Processing” will be displayed as below.

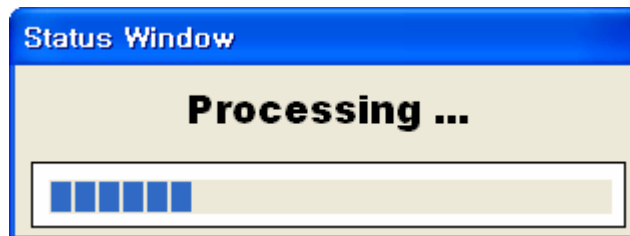

Figure 10. Firmware uploading window

⑥ When uploading is complete, a message box with “Complete Uploading” will be displayed as shown in below figure.

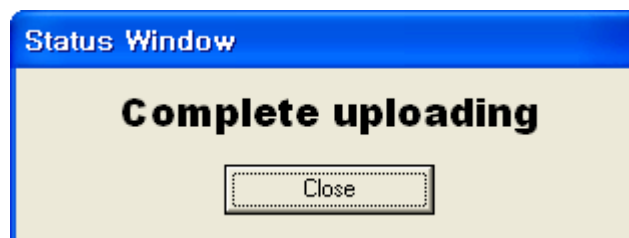

Figure 11. Complete Uploading

## 4. Demonstration and Test

This chapter will show how WIZ110SR operates through demonstration and test. The hardware and software for the testing is shown in below table.

	PC	WIZ110SR
Hardware	1) RS232 Port 2) LAN Port	1) WIZ110SR Board 2) Serial Cable 3) LAN Cable 4) DC5V Power Adaptor
Software	1) Configuration Tool Program 2) Hyper Terminal	

### 4.1 Hardware Interface



Figure 12. WIZ110SR Interface

Install the board as below steps.

**STEP 1:** Connect the WIZ110SR to the network by using RJ45 Ethernet cable.

**STEP 2:** Connect the WIZ110SR to the serial device by using Serial cable

**STEP 3:** Connect the power adaptor to WIZ110SR board.

## 4.2 Testing “Serial to Ethernet” Function

STEP1: Connect the power to the WIZ110SR board.

STEP2: By using Configuration Tool program, set the board.

STEP3: Run a Hyper Terminal or any other terminal emulator.

STEP4: Set the baud rate with same value of WIZ110SR.

STEP5: Run one more Hyper terminal, and set the IP address and port number by using TCP/IP (Winsock)

STEP6: Type some characters at the Serial Hyper Terminal screen. For example input “01234567890”.

STEP7: Check if above characters are displayed at the Network Hyper Terminal opened at the STEP 5. (Serial -> Ethernet)

STEP8: Input any character at the Network Hyper Terminal and check if it is displayed at the Serial Hyper Terminal screen. (Ethernet -> Serial)

\* Above function can be tested through Device Terminal Program that WIZnet is providing. The program is downloadable at the Library page of WIZnet homepage ([http://www.wiznet.co.kr/support\\_download.htm](http://www.wiznet.co.kr/support_download.htm)). By using Device Terminal program, the data communication between serial and Ethernet can be easily and simply tested.

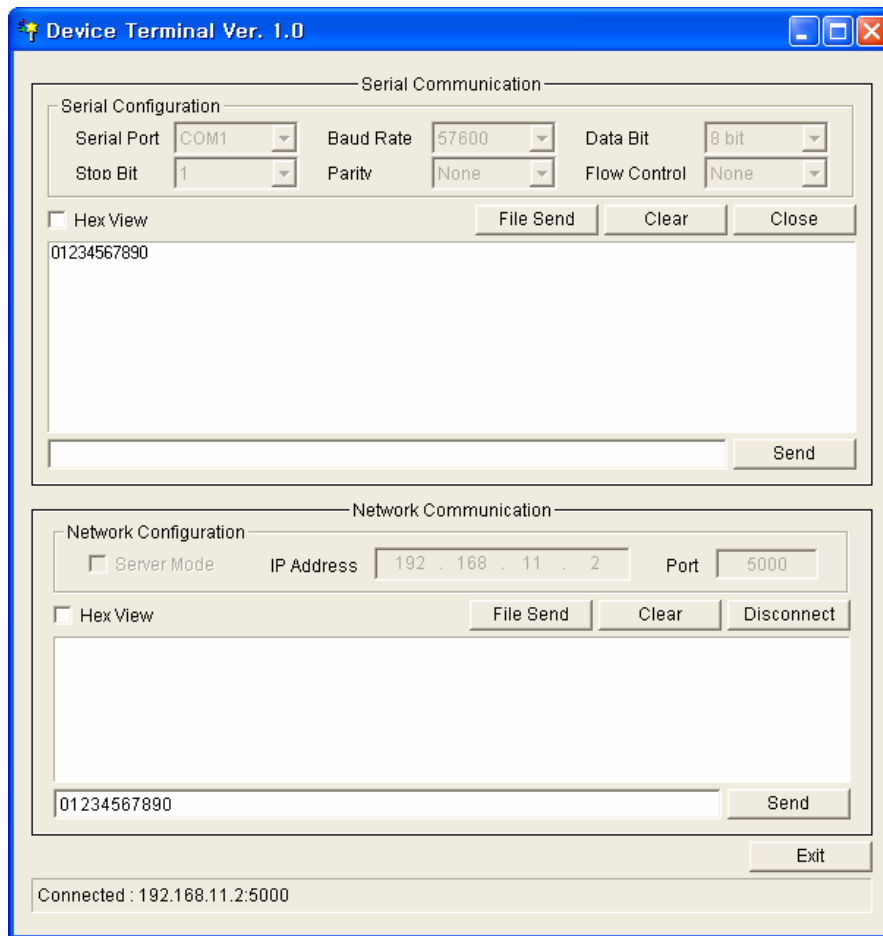

Figure 13. Device Terminal

## 5. Hardware Description of WIZ110SR

### 5.1 Parameters

- Power 5V DC / 180mA
- Dimension 75 x 50 x 17 (L x W x H)
- Temperature Operating : 0 ~ 80 °C
- Ethernet 10/100 Base-T Ethernet (Auto detection)
- Serial interface RS-232

### 5.2 Specification

- MCU 8051 Compliant
- FLASH 62KByte (MCU Internal)
- SRAM 16KByte (MCU Internal)
- EEPROM 2KByte (MCU Internal)

### 5.3 Board Dimensions and Pin Assignment

#### 5.3.1 Dimensions

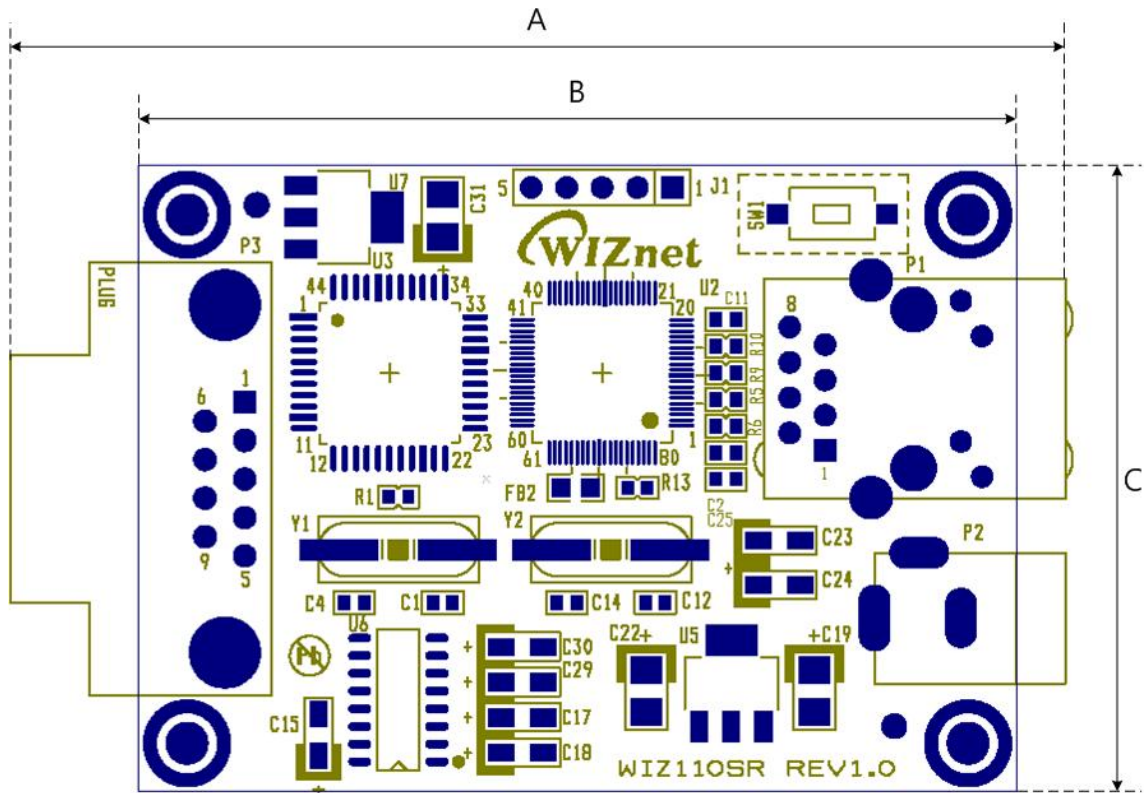

A	75.6mm
B	62.6mm
C	44.8mm

Figure 14. WIZ110SR Board Dimension

### 5.3.2 Connector Description

#### 5.3.2.1 RJ45

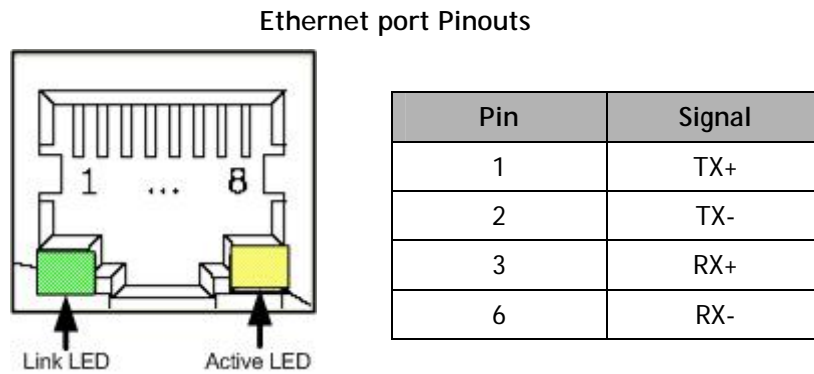
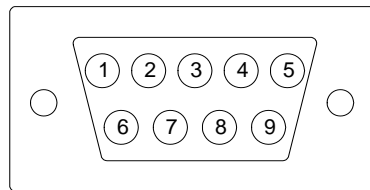

Figure 15. RJ-45 PIN Assignment

#### 5.3.2.2 RS-232



Pin Number	Signal	Description
1	NC	Not Connected
2	RxD	Receive Data
3	TxD	Transmit Data
4	DTR	Data Terminal Ready
5	GND	Ground
6	DSR	Data Set Ready
7	RTS	Request To Send
8	CTS	Clear To Send
9	NC	Not Connected

Figure 16. RS-232 PIN Assignment



## 6. Warranty

WIZnet Co., Ltd offers the following limited warranties applicable only to the original purchaser. This offer is non-transferable.

WIZnet warrants our products and its parts against defects in materials and workmanship under normal use for period of standard ONE(1)YEAR for the WIZ110SR board and labor warranty after the date of original retail purchase. During this period, WIZnet will repair or replace a defective products or part free of charge.

### Warranty Conditions:

1. The warranty applies only to products distributed by WIZnet or our official distributors.
2. The warranty applies only to defects in material or workmanship as mentioned above in 6.Warranty. The warranty applies only to defects which occur during normal use and does not extend to damage to products or parts which results from alternation, repair, modification, faulty installation or service by anyone other than someone authorized by WIZnet Inc. ; damage to products or parts caused by accident, abuse, or misuse, poor maintenance, mishandling, misapplication, or used in violation of instructions furnished by us ; damage occurring in shipment or any damage caused by an act of God, such as lightening or line surge.

### Procedure for Obtaining Warranty Service

1. Contact an authorized distributors or dealer of WIZnet Inc. for obtaining an RMA (Return Merchandise Authorization) request form within the applicable warranty period.
2. Send the products to the distributors or dealers together with the completed RMA request form. All products returned for warranty must be carefully repackaged in the original packing materials.
3. Any service issue, please contact to [sales@wiznet.co.kr](mailto:sales@wiznet.co.kr)